







ST 010 101 4705



- 160mm projection
- fixed spout
- rectangular spray pattern with 40 individual jets
- height of mixer 108 mm
- height up to aerator 94 mm
- hole diameter valve 32 mm
- hole diameter spout 35 mm
- rosette 60 x 47 mm
- 2x screw-in M 10 x 1 pressure hose, leak-tested
- max. flow 4 l/min
- lead-free
- This product can help a building meet the requirements of Green Building Rating Systems, e.g. LEED®, BREEAM®, DGNB

	Dark Chrome	ST 010 101 4705-19
	Chrome	ST 010 101 4705-00
	Brushed Platinum	ST 010 101 4705-06
	Brushed Champagne (22kt Gold)	ST 010 101 4705-46
	Champagne (22kt Gold)	ST 010 101 4705-47
	Brushed Dark Platinum	ST 010 101 4705-99

Individual components of this set

You need the following components for this set

1x 13 714 705-19



1x 20 004 705-19









1x 20 004 706-19



ST 010 101 4705



- 160mm projection
- fixed spout
- rectangular spray pattern with 40 individual jets
- height of mixer 108 mm
- height up to aerator 94 mm
- hole diameter 35 mm
- 2x screw-in M 10 x 1 pressure hose, leak-tested
- 1/2" connection
- max. flow 4 l/min
- lead-free
- This product can help a building meet the requirements of Green Building Rating Systems, e.g. LEED®, BREEAM®, DGNB

	Dark Chrome	13 714 705-19
	Chrome	13 714 705-00
	Brushed Platinum	13 714 705-06
	Brushed Champagne (22kt Gold)	13 714 705-46
	Champagne (22kt Gold)	13 714 705-47
	Brushed Dark Platinum	13 714 705-99

ST 010 101 4705

mm [inches]

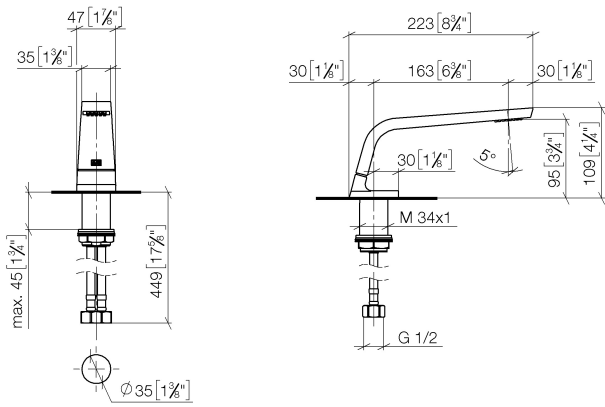

Flow rate chart

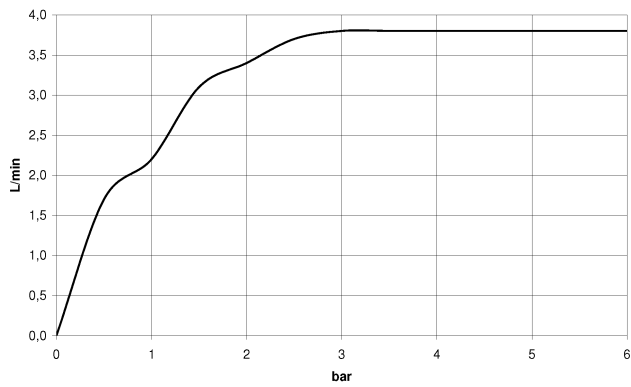

Certificates

GDV_0400279. IAPMO_N-4976. IAPMO_6397.





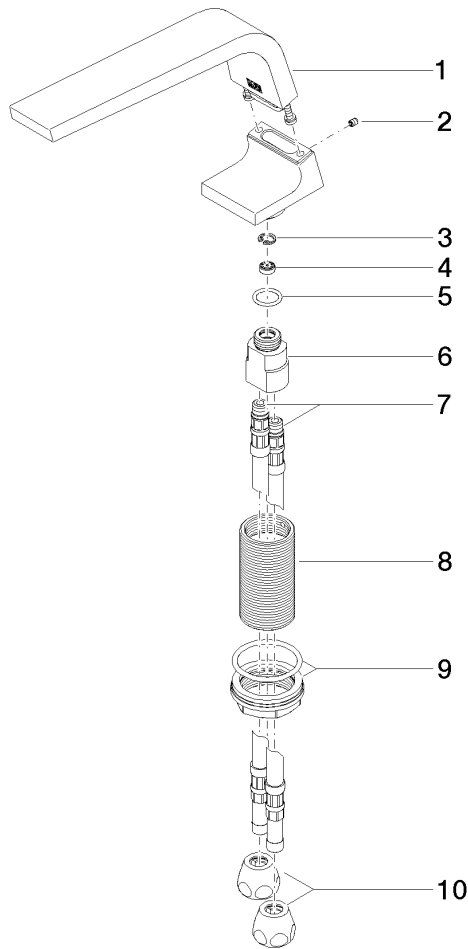

ST 010 101 4705

Parts for other finishes can be found here: [Chrome](#)



- hole diameter 32 mm
- rosette 60 x 47 mm
- with cold marking



	Dark Chrome	20 004 705-19
	Chrome	20 004 705-00
	Brushed Platinum	20 004 705-06
	Brushed Champagne (22kt Gold)	20 004 705-46
	Champagne (22kt Gold)	20 004 705-47
	Brushed Dark Platinum	20 004 705-99



CL.1 Three-hole basin mixer without pop-up waste - Dark Chrome

CL.1

ST 010 101 4705

ST 010 101 4705

mm [inches]

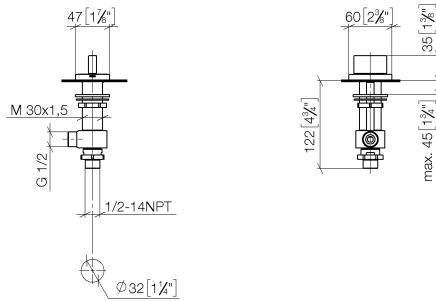

Flow rate chart

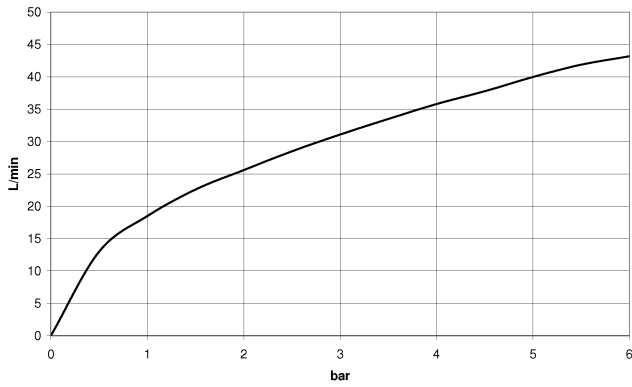

Certificates

IAPMO_N-4976.

LGA_28687.

IAPMO_6397.

WRAS_240202020.

ST 010 101 4705

Parts for other finishes can be found here: [Chrome](#)

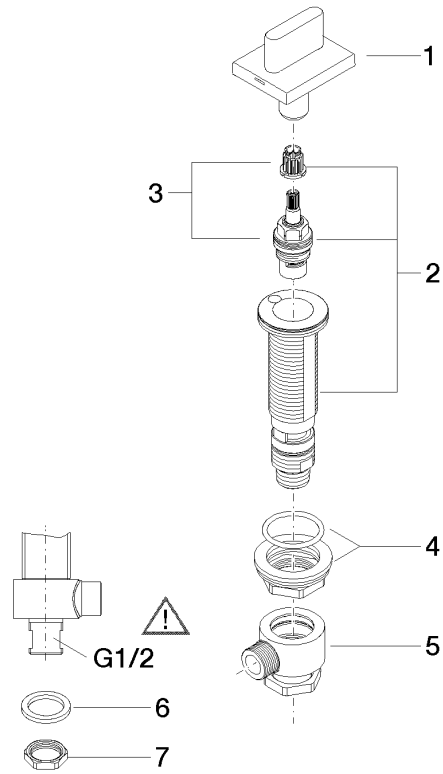







Spare parts list

No.	Item Number	Name	Quantity used	Delivery time
1	90 20 70 051 06-19	handle (cold)	1	20
2	04 17 11 058 53 90	side panel	1	2
3	90 90 03 153 00 90	top	1	2
4	04 23 10 032 78 90	fixing set	1	2
5	04 17 11 023 10 90	distributor	1	2
6	90 23 30 040 00-19	threaded connector	1	-
Spare part can no longer be ordered, please order the replacement item				
7	09 30 11 059 90	disc	1	2
8	09 23 10 012 90	nut	1	2

ST 010 101 4705

- hole diameter 32 mm
- rosette 60 x 47 mm
- with hot marking



	Dark Chrome	20 004 706-19
	Chrome	20 004 706-00
	Brushed Platinum	20 004 706-06
	Brushed Champagne (22kt Gold)	20 004 706-46
	Champagne (22kt Gold)	20 004 706-47
	Brushed Dark Platinum	20 004 706-99

ST 010 101 4705

mm [inches]

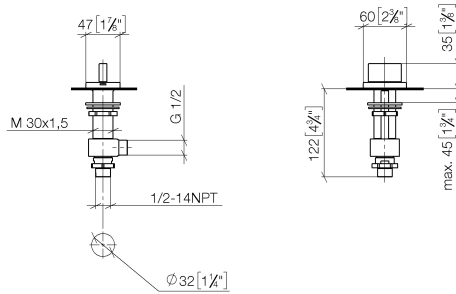

Flow rate chart

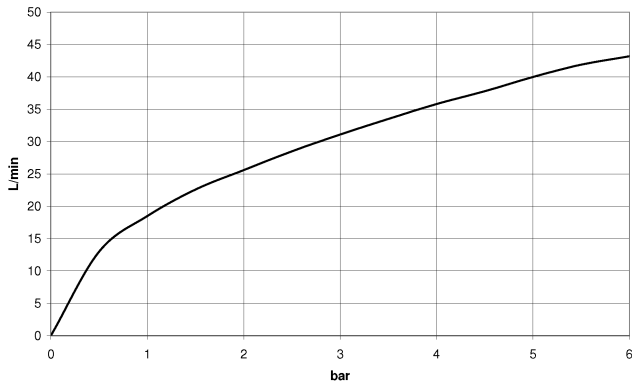

Certificates

IAPMO_N-4976.

LGA_28687.

IAPMO_6397.

WRAS_240202020.

ST 010 101 4705

Parts for other finishes can be found here: [Chrome](#)

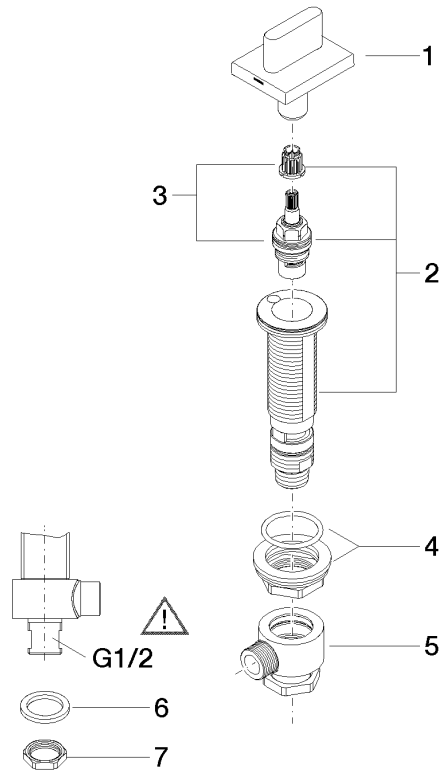

Spare parts list

No.	Item Number	Name	Quantity used	Delivery time
1	90 20 70 051 07-19	handle (hot)	1	20
2	04 17 11 058 52 90	side panel	1	2
3	90 90 03 152 00 90	top	1	2
4	04 23 10 032 78 90	fixing set	1	2
5	04 17 11 023 10 90	distributor	1	2
6	90 23 30 040 00-19	threaded connector	1	-
Spare part can no longer be ordered, please order the replacement item				
7	09 30 11 059 90	disc	1	2
8	09 23 10 012 90	nut	1	2